

全部

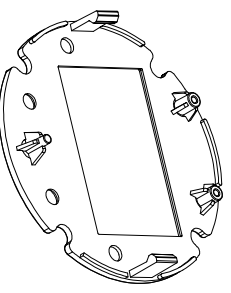
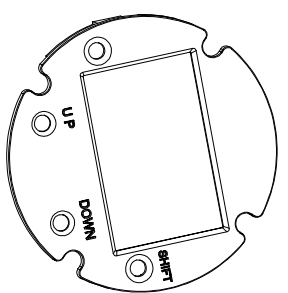
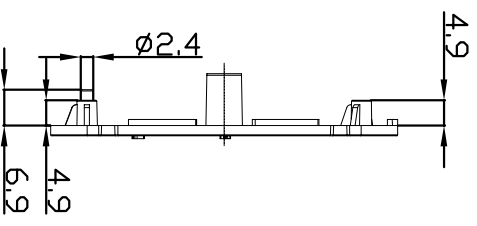
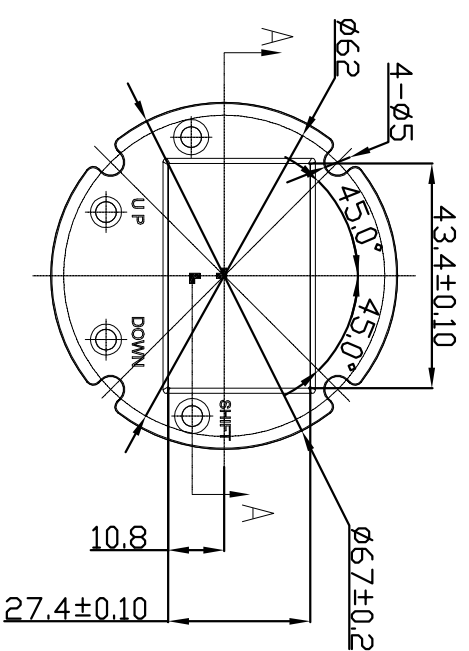
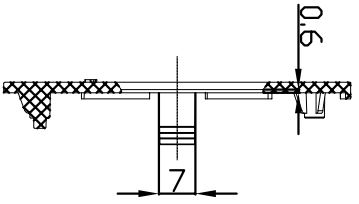
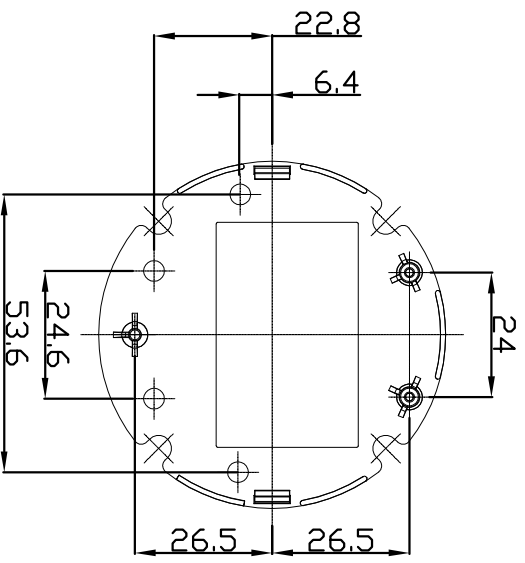
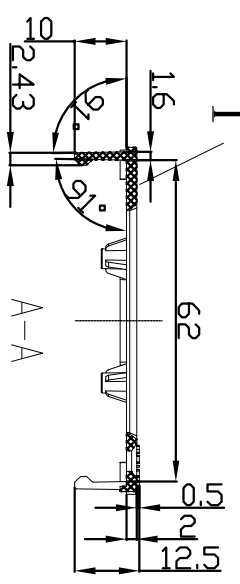

- 技术要求:
- 1、材料牌号：拜耳T45 (PC+ABS) ；
 - 2、颜色：黑色；
 - 3、零件不允许有明显的收缩、飞边等缺陷；
 - 4、未标注尺寸参照3D图；
 - 5、未标注公差按IT12级进行；
 - 6、其中 I 面为外观面，进胶口不得设置在该面，进胶口处理干净；
 - 7、外表面做皮纹处理。

| | | | | | |
|---------------|----------------|---------------|-----------------------|-----------------------|--------|
| 制图 Drawing | 审核 Auditing | 批准 Confirm | 客户名称 Customer Name | 材料 Material | ABS+PC |
| | | | 产品名称 Product Name | 图样比例 Drawing Scale | A3 |
| | | | 产品编号 Product Code | 范围 Project View | |
| | | | 28-422 | | |

宁波三和壳业有限公司
NINGBO SANHE ENCLOSURE CORPORATION
中国·宁波慈溪
TEL: +865743285510
FAX: +865743285510

1 2 3 4 5 6

共 页 第 页