

1 2 3 4 5 6

A

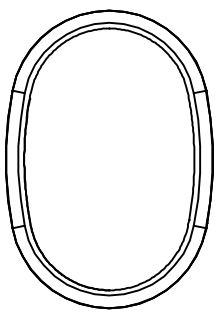

A

B

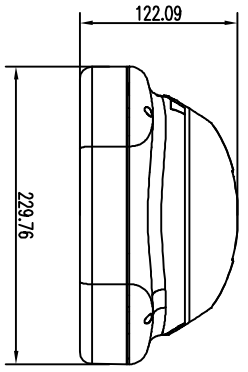

B

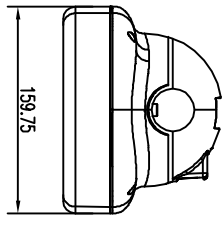
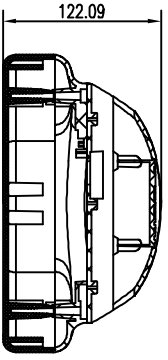

C

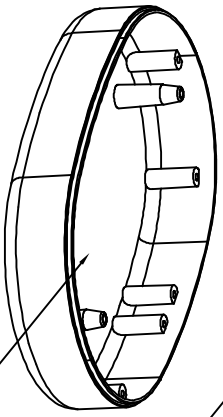
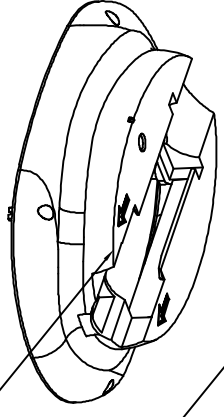

C

D

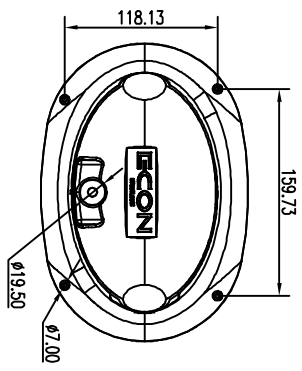

序号 Number	产品编号 Product Code	零件名称 Part Name	数量 Quantity	材料 Material	重量/g Weight	备注 REMARKS
1	28-402-1	上壳	1	ABS		配4个M3X5.5MM耐高温嵌件
2	28-402-2	中壳	1	ABS		
3	28-402-3	底壳	1	ABS		
4	28-402-4	透明盖	1	透明PC		

制图 Drawing	审核 Auditing	批准 Confirm	客户名称 Customer Name	产品名称 Product Name	产品编号 Product Code	视图 Project View	比例 Scale
				装配图	28-402		A

D