

截面 A-A

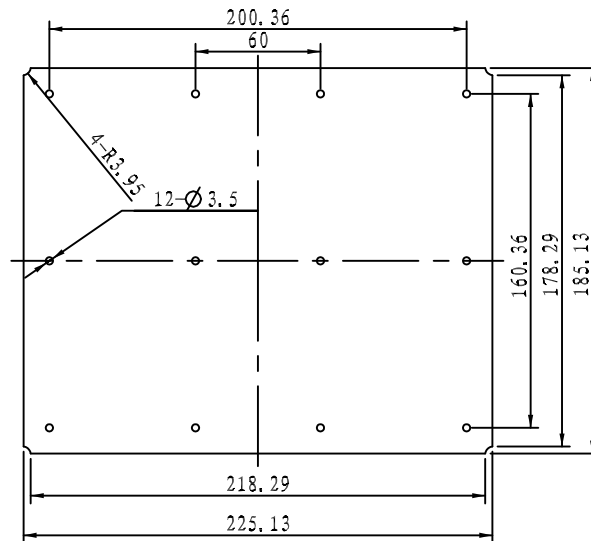

建议PCB尺寸

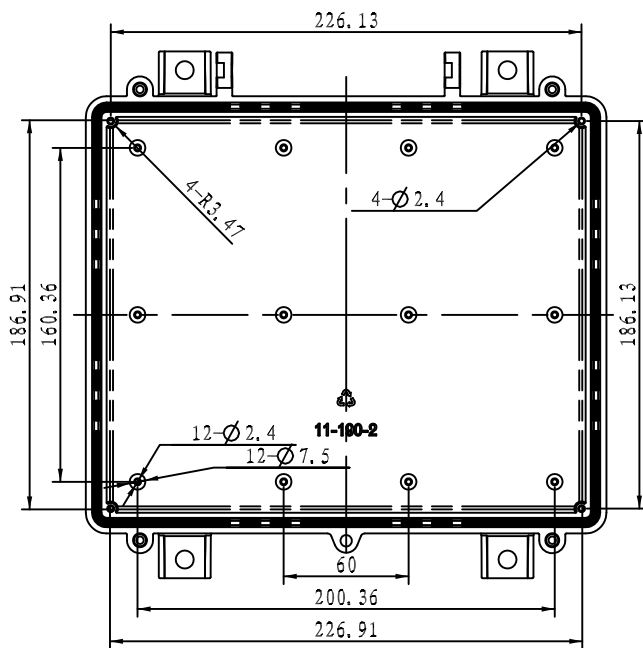
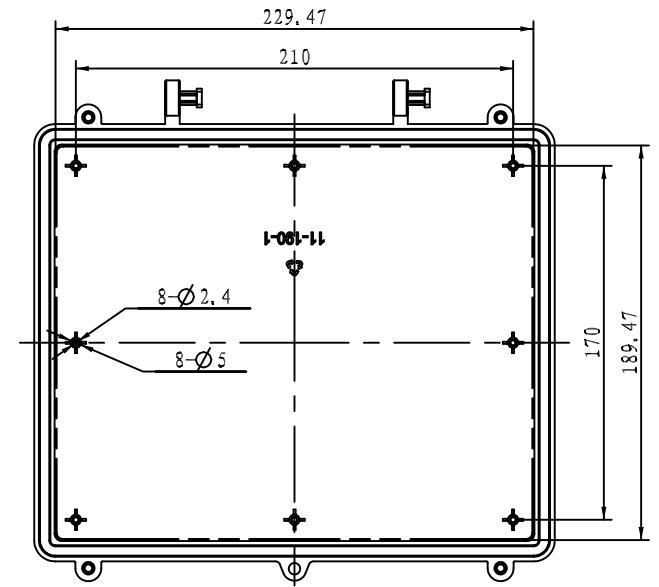
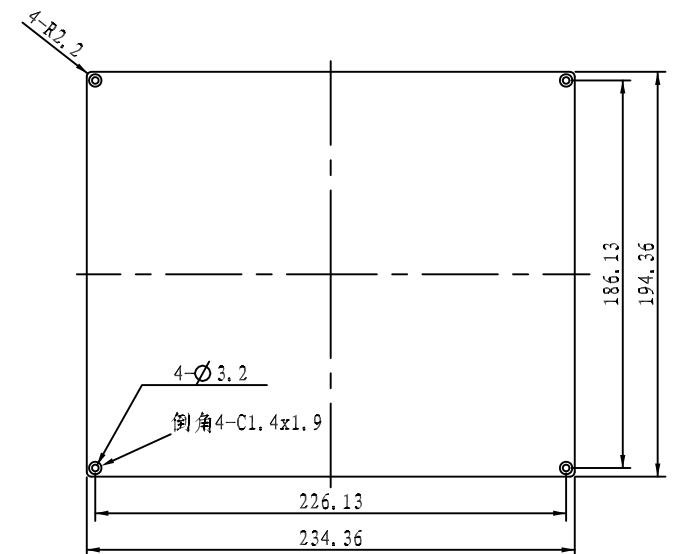

面板

安装说明 (Installation instructions)

型号Code: 11-190

尺寸Size: 250x253x100mm

防护等级ProtectionClass: IP65

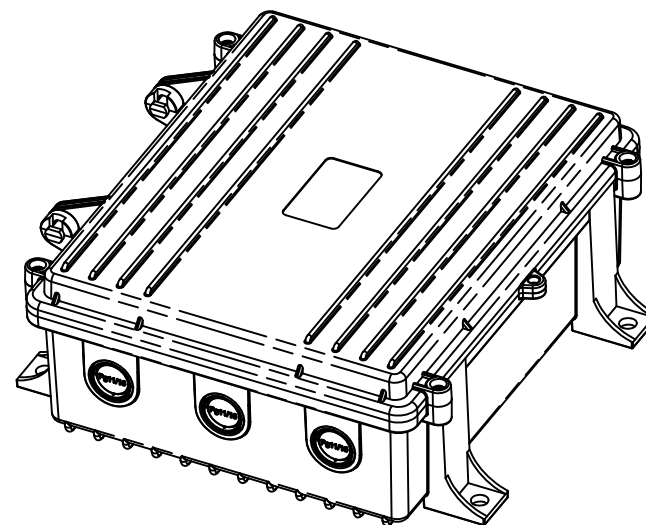
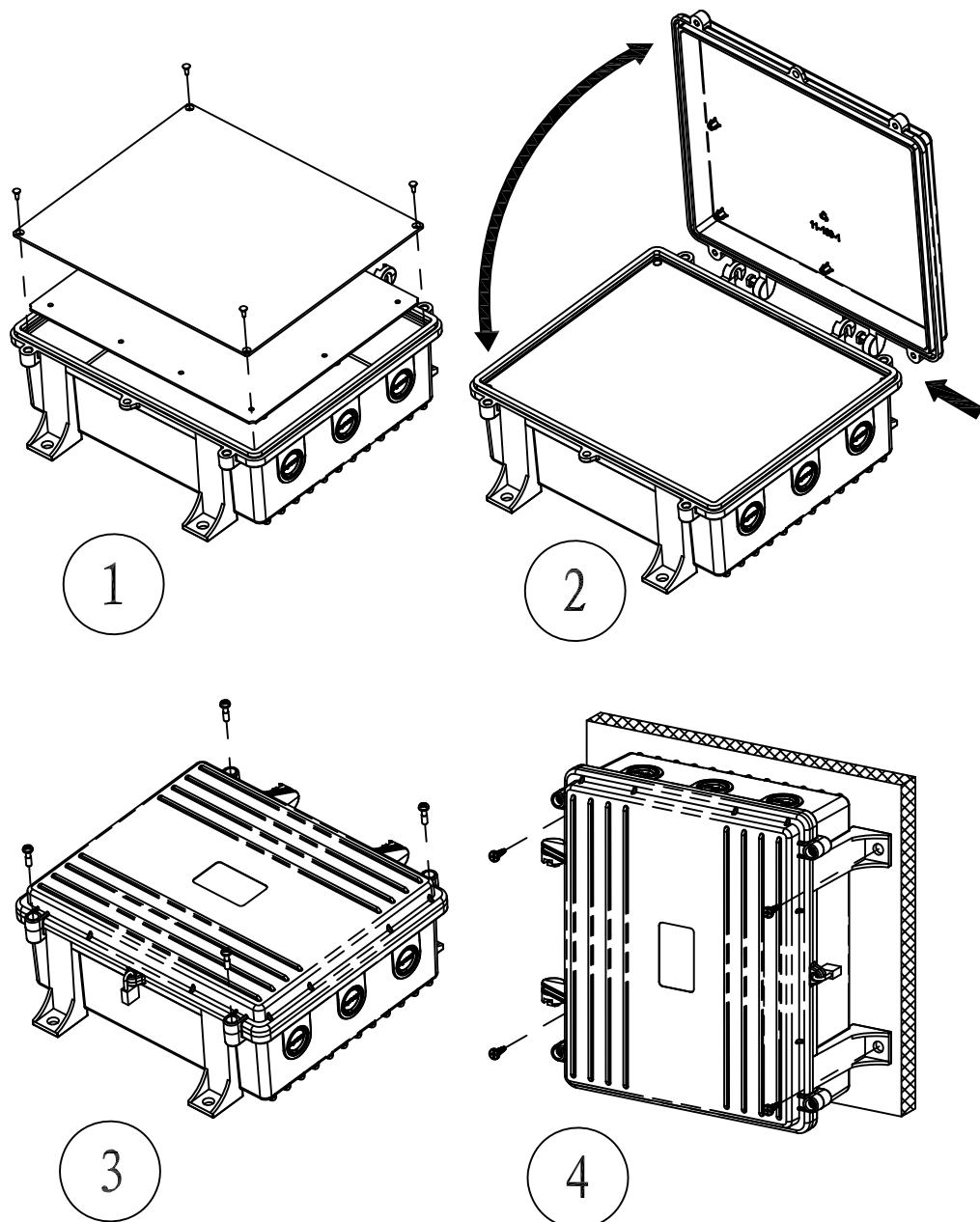

宁波三和壳体公司

NINGBO SANHE ENCLOSURE CORPORATION

<http://www.china-mould.com>