

安装说明 (Installation Instructions)

①

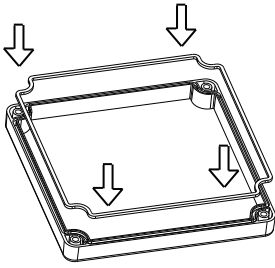

②

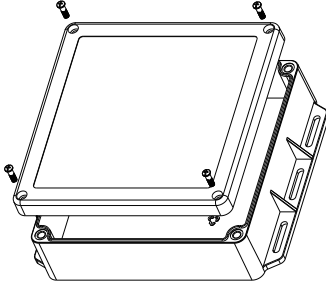

③

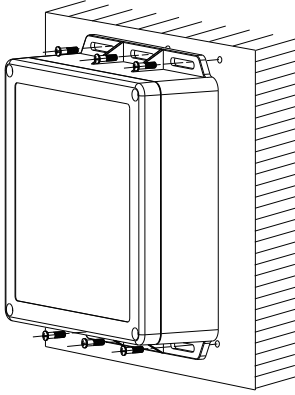

型号Code:11-178
 尺寸Size:205x177x60mm
 防护等级ProtectionClass:IP65

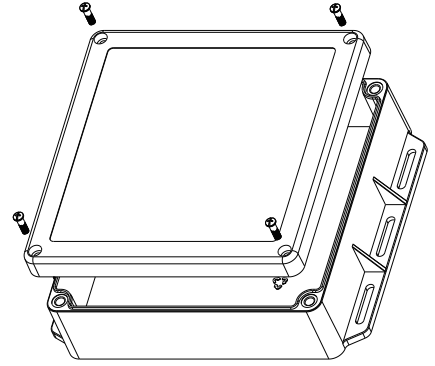

宁波三和壳体公司
 NINGBO SANHE ENCLOSURE CORPORATION

<http://www.china-mould.com>

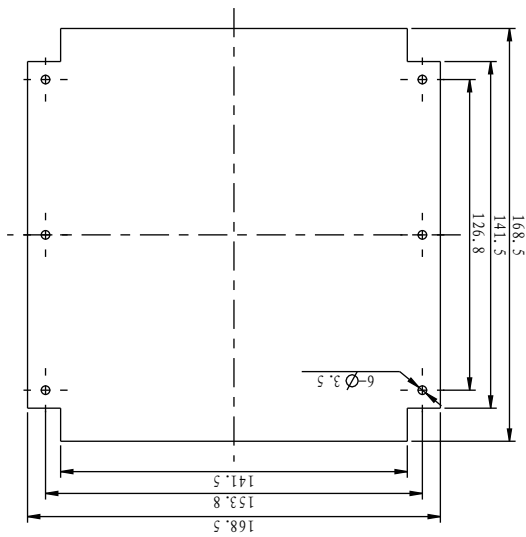

PCB

