

正面

背面(顶杆做此面)

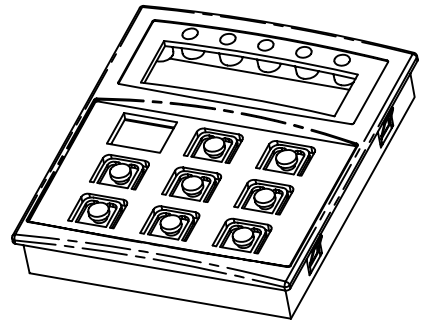
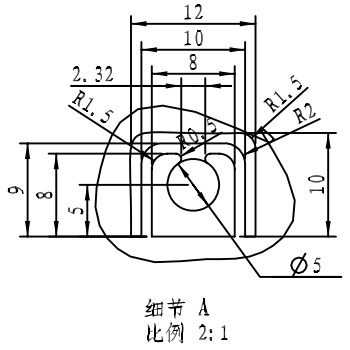
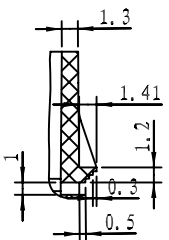
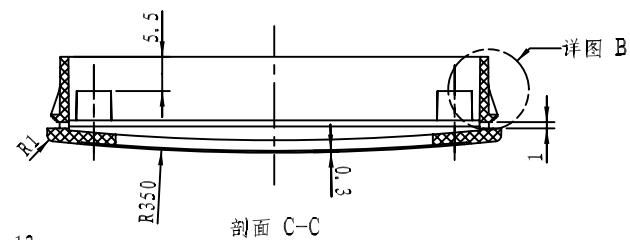
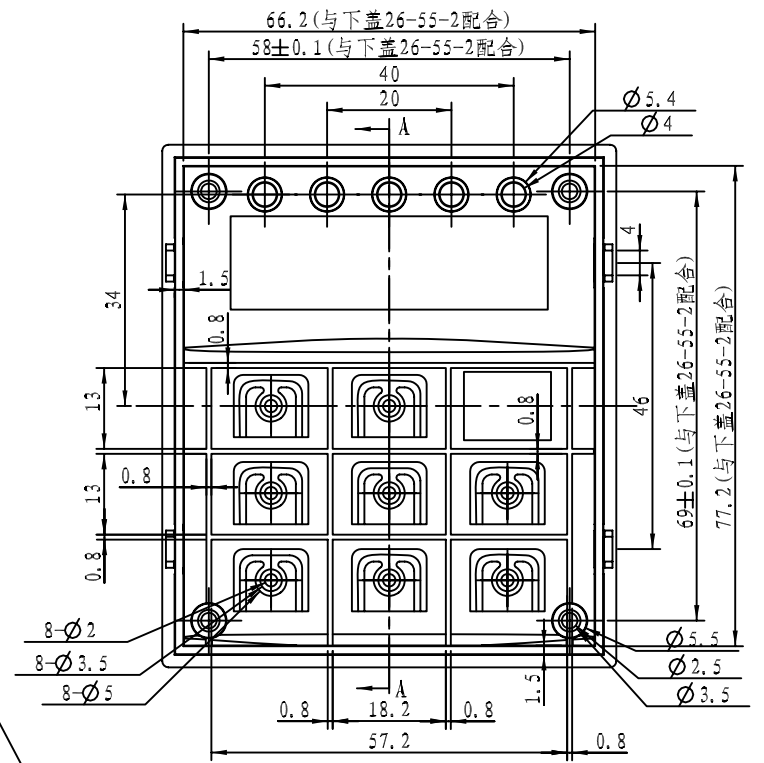
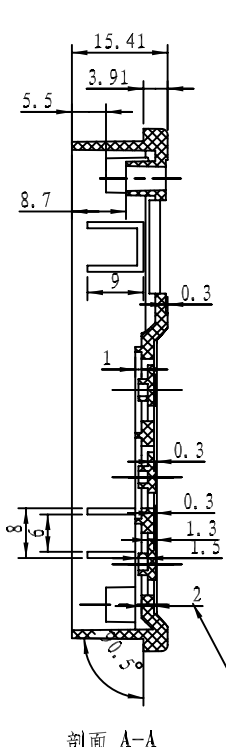
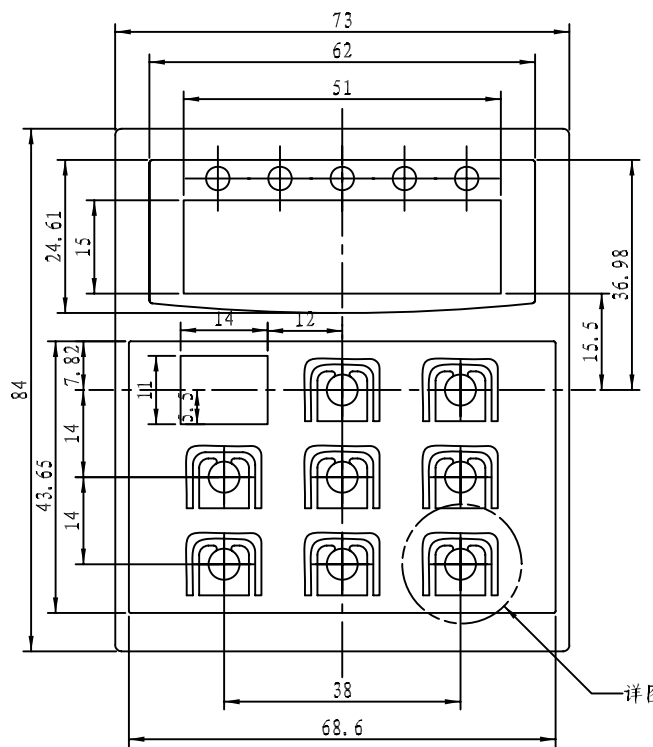

底部壁厚加厚为2mm.

技术要求

- 1, 材料为普通ABS, 表面光洁度为细砂面, 细砂程度按样品。
- 2, 颜色按样品。
- 3, 产品表面不应有划痕、擦伤、缩痕、飞边等缺陷。
- 4, 上盖应与下盖26-55-2和配合紧密。
- 5, 未注形状公差符合GB1184-80的要求

细节 B
比例 12:5

细节 A
比例 2:1

比例 4:5

制图 Drawing	审核 Auditing	批准 Confirm	客户名称 Custom Name	台州富凌(单方)	材料 Material	普通ABS	
熊小花			产品名称 Product Name	编程器上盖	图例比例 Drawing Scale	1:2:1	A3
08.7.21			产品编号 Product Code	26-55-1	视图 Project View	(mm)	
共 1 页			第 1 页		宁波三和壳体公司 NINGBO SANHE ENCLOSURE CORPORATION		中国宁波慈溪 TEL:+86(574)6322690 FAX:+86(574)6322690