

反面（顶杆放此面）

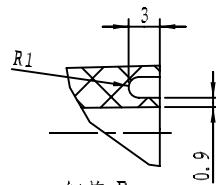

细节 B
比例 2:1

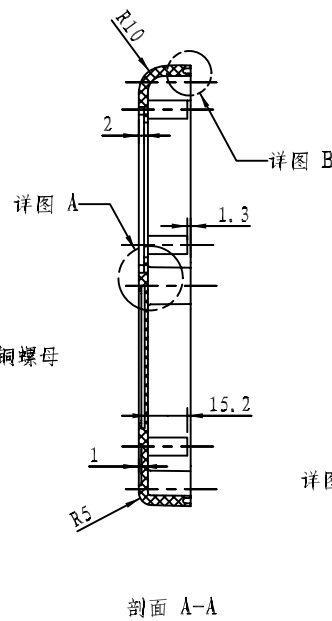

剖面 A-A

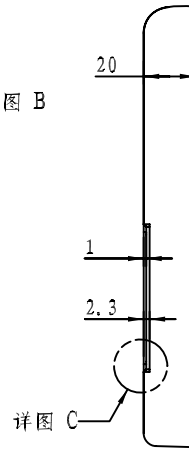

详图 C

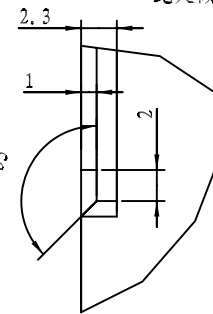

细节 C
比例 3:1

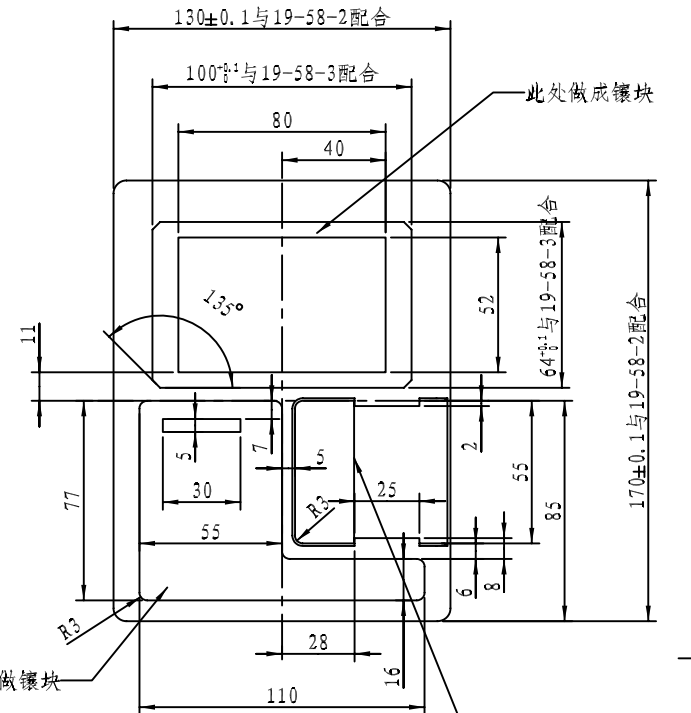

正面（外表面）

技术要求与说明

- 一. 材料为阻燃ABS, 颜色为深灰色, 表面砂面;
- 二. 产品表面不应有划痕, 擦伤, 缩印, 飞边等缺陷;
- 三. 未注形状公差按GB1184-80的要求;

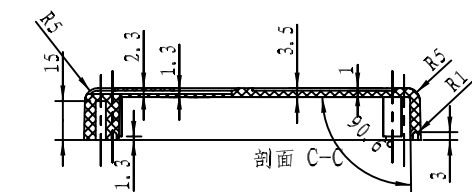

剖面 C-C

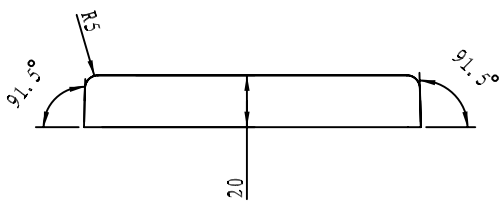

细节 A
比例 2:1

制图 Drawing	审核 Auditing	批准 Confirm	客户名称 Custom Name	上海同焱电子科技 宁波三和壳体公司	材料 Material	阻燃ABS	
滕久君			产品名称 Product Name	上盖	图纸比例 Drawing Scale	1:2	A3
07.09.24			产品编号 Product Code	19-58-1A	视图 Project View	(mm)	
共 1 页			第 1 页		宁波三和壳体公司 NINGBO SANHE ENCLOSURE CORPORATION		中国宁波慈溪 TEL: +86(574)63226910 FAX: +86(574)63226900